

New Winbreak MCCB

We touch your **electricity** everyday!

State of the art Manufacturing Facilities



Haridwar, Noida Ph-I & Noida Ph-II Plant



New Winbreak



C&S Electric Ltd.

Corporate Office : 222, Okhla Industrial Estate, New Delhi - 110 020
Tel. : +91-11-3088 7520 - 29, Fax: +91-11-2684 7154, 2682 9063

International Business Division: Tel. : +91-11-4161 3503, 3088 7520-29, Fax: +91-11-2683 8291, 2684 7342
email : exports@cselectric.co.in

Central Marketing Office: Tel. : +91-11-3088 7520-29, Fax: +91-11-2684 8241, 2684 7342
email : cmo@cselectric.co.in, info@cselectric.co.in



Moulded Case Circuit Breaker

upgrade of WiNbreak series **New WiNbreak**



Compatible and differentiated design

- Compatible with WiNbreak MCCB

Upgrade the coordination

- Upgrade the coordination with WiNbreak2 MCCB

Upgrade breaking capacity

100AF: 10	→	18kA
125AF: 25	→	37kA
250AF: 25	→	37kA
250AF: 35	→	50kA
400AF: 25	→	37kA
400AF: 35	→	50kA
800AF: 50	→	65kA
Ics = 100% Icu		

Upgrade breaking capacity

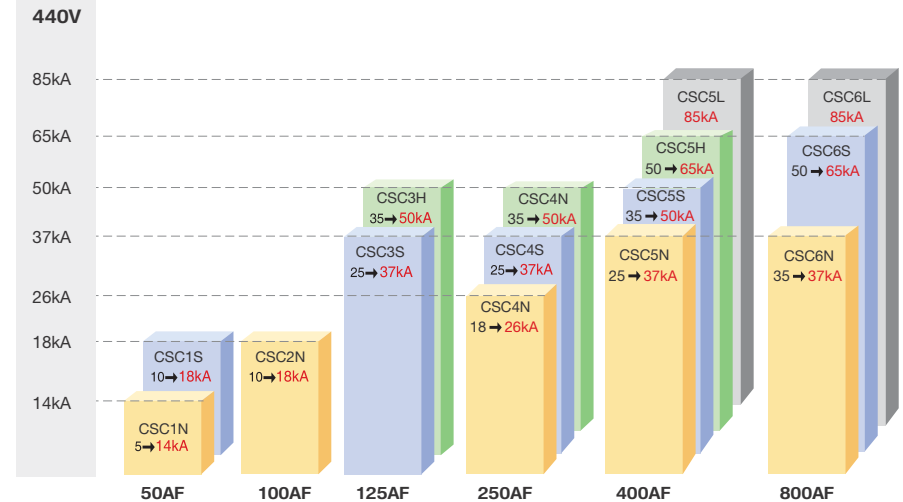

External Configuration

- Fixed Thermal Magnetic MCCB
- 100% compatible with WiNbreak MCCB
- Standardized dimension (depth, cutout) offering flexibility for panel designers.

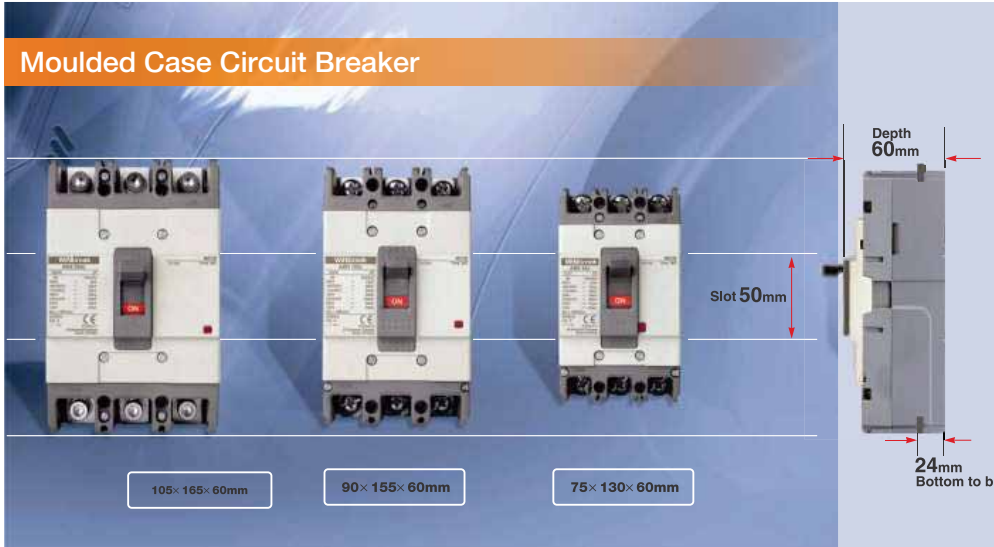

Short Circuit Breaking Capacity

W Nbreak	kA	Model
85	85	CSC-L
50	50	CSC-H
37	37	CSC-S
18	18	CSC-N
10	10	

Upgraded Breaking Capacity

100AF	125AF	250AF	250AF
10 → 18kA	25 → 37kA	25 → 37kA	35 → 50kA
400AF	400AF	630AF	800AF
25 → 37kA	35 → 50kA	50 → 65kA	50 → 65kA

Handle

- Function of indications - "ON" "OFF" "TRIP"
- Resetting - When the handle indicate "tripped" position it must first be reset by moving the handle to the "OFF" position and then closing is possible
- Trip-Free even if the handle is held at "ON", the breaker will trip if an over current flows
- Suitable for verification of the main contact position under abnormal conditions because the handle doesn't indicate position

Arc-Extinguishing unit

- Patent technique PASQ Arch-Extinguishing
PASQ (Puffer Assisted Self-Quenching)
- Reduce of arc voltage for a short time

Trip button (push to trip)

Enables tripping mechanically for outside, for confirming to operation of the MCCB and the manual resetting function.

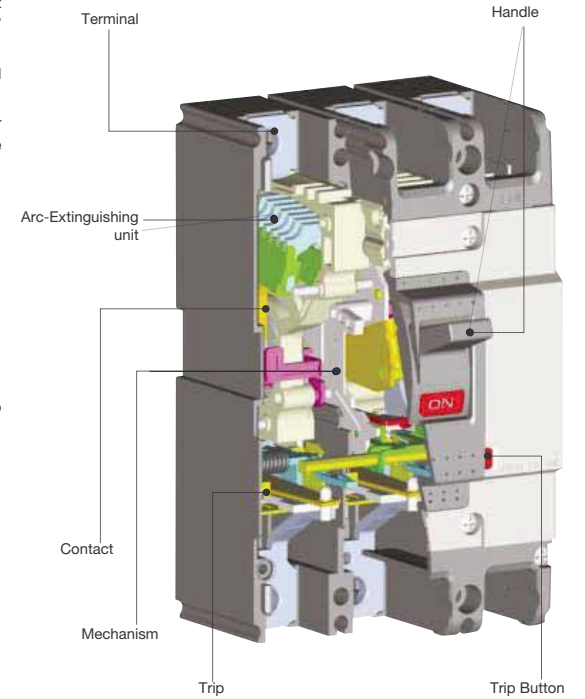
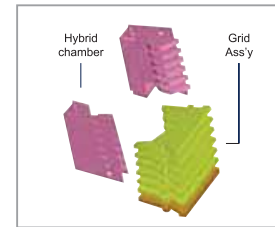

Application of PASQ Arc Extinguishing

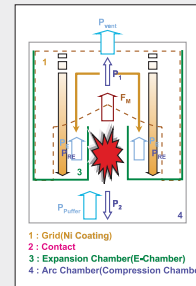

The reduction of breaking time by applying PASQ arc extinguishing for inhibition of arc voltage for a short time.

Application of Current limiting structure

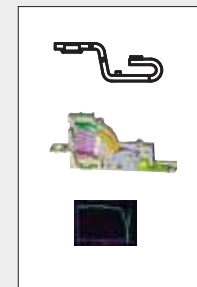

- Current limiting repulsion structure (U fixed structure)
- Toggle structure: When the operating unit repulses by short circuit current, repulsion structure at bigger angle.

Selection Table

AF		50AF		100AF
Frame type		CSC1		CSC2
Type		N-Type	S-Type	N-Type
Type and Pole	2-pole	CSC1N2	CSC1S2	CSC2N2
	3-pole	CSC1N3	CSC1S3	CSC2N3
	4-pole	CSC1N4	CSC1S4	CSC2N4
Rated current, I _n	A	15,20,30,40,50		60, 75, 100
Rated operational voltage, U _e	AC(V)	690	690	690
	DC(V)	500	500	500
Rated insulation voltage, U _i	V	750	750	750
Rated impulse withstand voltage, U _{imp}	kV	8	8	8
Rated short-circuit breaking capacity(I_{cu}) kA (Sym), IEC 60947-2				
AC	690V	2.5	5	5
	480/500V	7.5	10	10
	415/460V	14	18	18
	380V	18	22	22
	220/250V	30	35	35
DC	500V(3P)	5	10	10
	250V(2P)	5	10	10
I _{cs} =% × I _{cu}		100	100	100
Dimensions (mm)	W × H × D	75 × 130 × 60mm		75 × 130 × 60mm
	(3-pole)	(Fig. 1)		(Fig. 1)

125AF			250AF		
CSC3			CSC4		
S-Type	H-Type	N-Type	S-Type	H-Type	
-	-	CSC4N2	-	-	
CSC3S3	CSC3H3	CSC4N3	CSC4S3	CSC4H3	
CSC3S4	CSC3H4	CSC4N4	CSC4S4	CSC4H4	
15, 20, 30, 40, 50, 60, 75, 100, 125		100, 125, 150, 175, 200, 225, 250	150, 175, 200, 225, 250		
690	690	690	690	690	
500	500	500	500	500	
750	750	750	750	750	
8	8	8	8	8	
Rated short-circuit breaking capacity(I_{cu}) kA (Sym), IEC 60947-2					
8	10	8	8	10	
26	35	18	26	35	
37	50	26	37	50	
42	50	30	42	50	
85	100	65	85	100	
20	30	10	20	30	
20	30	10	20	30	
100	100	100	100	100	
90 × 155 × 60mm			105 × 165 × 60mm		
(Fig. 2)			(Fig. 3)		

AF Type	50AF	100AF	125AF	250AF
CSC-N	CSC1N1 14kA	CSC2N 18kA		CSC4N 26kA
CSC-S	CSC1S 18kA		CSC3S 37kA	CSC4S 37kA
CSC-H			CSC3H 50kA	CSC4H 50kA

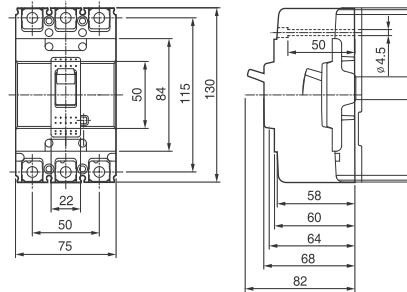

(Fig. 1)

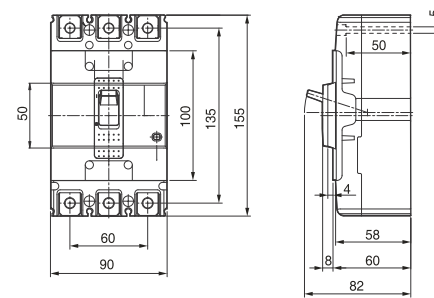

(Fig. 2)

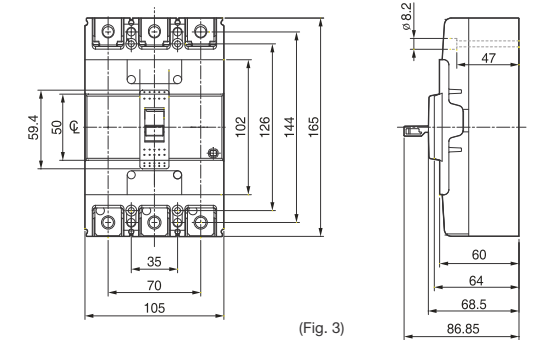

(Fig. 3)

Selection Table

AF		400AF			
Frame type		CSC5			
Type		N-Type	S-Type	H-Type	L-Type
Type and Pole	3-pole	CSC5N3	CSC5S3	CSC5H3	CSC5L3
	4-pole	CSC5N4	CSC5S4	CSC5H4	CSC5L4
Rated current, I _n	A	300, 350, 400		250, 300, 350, 400	
Rated operational voltage, U _e	AC(V)	690	690	690	690
	DC(V)	500	500	500	500
Rated insulation voltage, U _i	V	750	750	750	750
Rated impulse withstand voltage, U _{imp}	kV	8	8	8	8
Rated short-circuit breaking capacity(I_{cu}) kA (Sym), IEC 60947-2					
AC	690V	5	8	10	14
	480/500V	18	35	50	65
	415/460V	37	50	65	85
	380V	42	65	70	100
	220/250V	50	75	85	125
DC	500V(3P)	10	20	40	40
	250V(2P)	10	20	40	40
I _{cs} =% × I _{cu}		100	100	100	75
Dimensions (mm)	W × H × D (3-pole)	140 × 257 × 109mm (Fig. 4)			

800AF			1000AF		1200AF	
CSC6			CSC7		CSC8	
N-Type	S-Type	L-Type	S-Type	L-Type	S-Type	L-Type
CSC6N3	CSC6S3	CSC6L3	CSC7S3	CSC7L3	CSC8S3	CSC8L3
CSC6N4	CSC6S4	CSC6L4	CSC7S4	CSC7L4	CSC8S4	CSC8L4
	500, 630, 700, 800		1000		1200	
690	690	690				
500	500	500				
750	750	750				
8	8	8				
8	10	14				
25	45	65	50	75	50	75
37	65	85	65	85	65	85
45	75	100	65	85	65	85
50	85	125	100	125	100	125
10	20	40				
10	20	40				
100	100	75				
	210 × 280 × 109mm (Fig. 5)		220 × 400 × 105mm (Fig. 6)		220 × 400 × 105mm (Fig. 6)	

AF Type	400AF	800AF	1000AF	1200AF
CSC-N	CSC5N 37kA	CSC6N 37kA		
CSC-S	CSC5S 50kA	CSC6S 65kA	CSC7S 65kA	CSC8S 65kA
CSC-H	CSC5H 65kA			
CSC-L	CSC5L 85kA	CSC6L 85kA	CSC7L 85kA	CSC8L 85kA

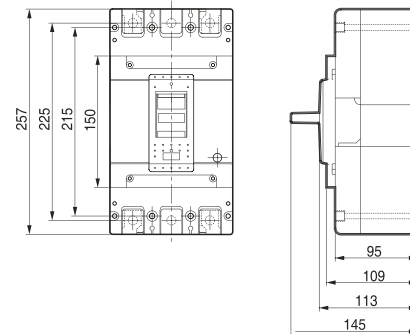

(Fig. 4)

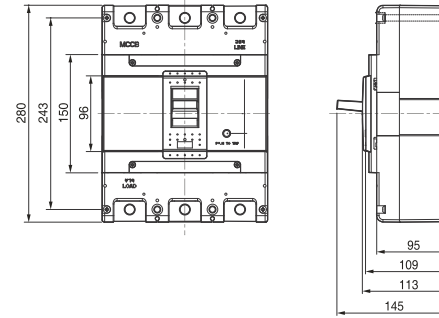

(Fig. 5)

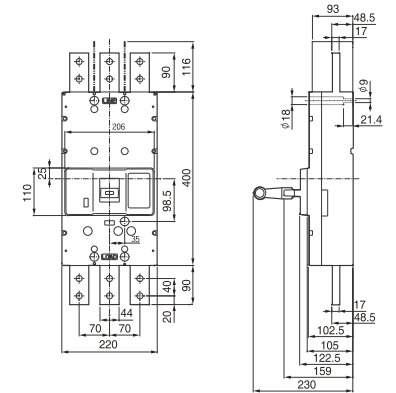

(Fig. 6)

Electrical accessories

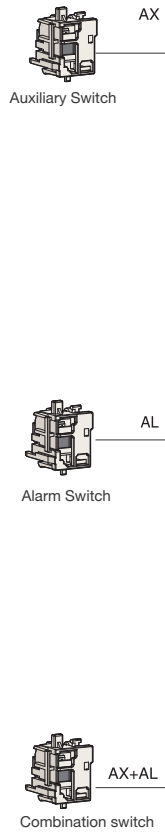

Option of connecting AX or AL or AX+AL
This seat is not available for 2 Pole breakers

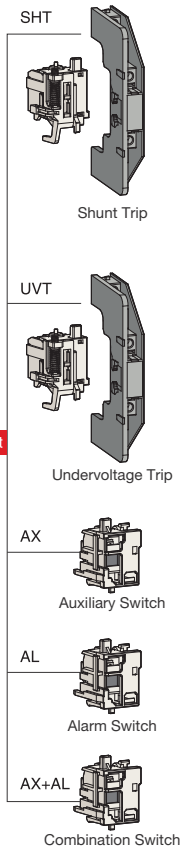
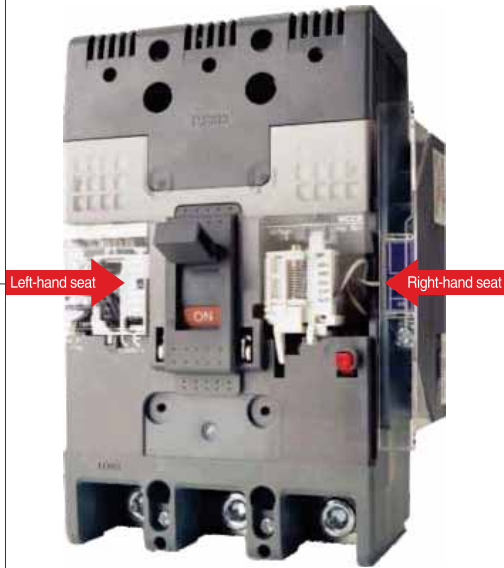

Option of connecting SHT or UVT or AX or AL or AX+AL



AL	AL	SHT or UVT
AX	AX	

Option for connection
AX or AL or AX+AL
This seat is not available for 2 pole breakers

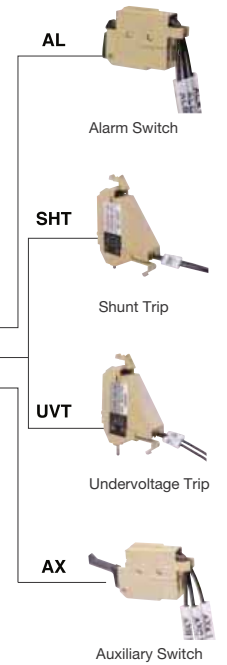
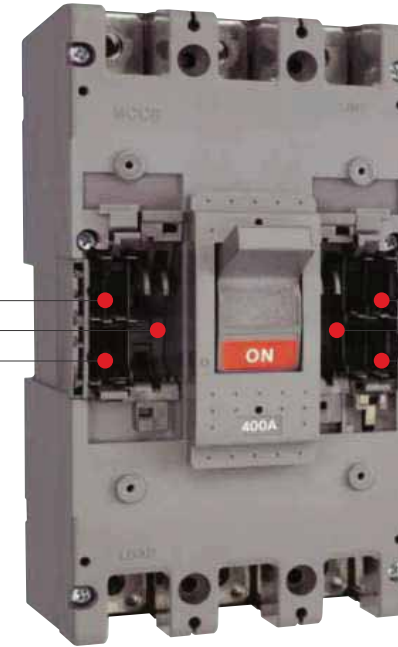

SHT or UVT	AL	AL
	AX	AX

Option for connection
SHT or UVT or AX or AL or AX+AL
This seat is not available for ELCB.

Maximum possibilities

Position	Type	CSC2		CSC3		CSC4
		2P	3/4P	2P	3/4P	3/4P
Left-hand seat	AX	-	1	-	1	1
	AL	-	1	-	1	1
Right-hand seat	AX	1	1	1	1	1
	AL	1	1	1	1	1
	SHT/UVT	1	1	1	1	1

Maximum possibilities

Position	Type	MCCB (400~800AF)
Left-hand seat	AX	2
	AL	2
	SHT/UVT	1
Right-hand seat	AX	2
	AL	2
	SHT/UVT	1

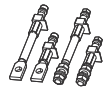

Front and rear connection

Several kinds of terminals can be equipped with ELCBs as well as MCCBs.
 - Terminals for front connection
 - Rear connection terminals



Plug-in base

It makes to extract and/or rapidly replace the circuit breaker without having to touch connections. (Easy replacement and maintenance)

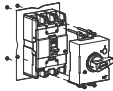

Direct & Extended Rotary Handle

There are two types of rotary handles.
 - Direct rotary handle (with or w/o key lock device)
 - Extended rotary handle

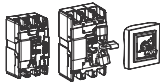

Locking device

- Fixed padlock
 - Removable padlock
 - Key lock device on direct handle



Insulation barrier

These allow the insulation characteristics between the phases at the connections to be increased.

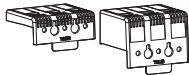

Insulation terminal cover

The terminal covers are applied to the circuit-breaker to prevent accidental contact with live parts and thereby guarantee protection against direct contacts.

CSC3S & CSC3H

Rated current: 15-30A, 40-140A

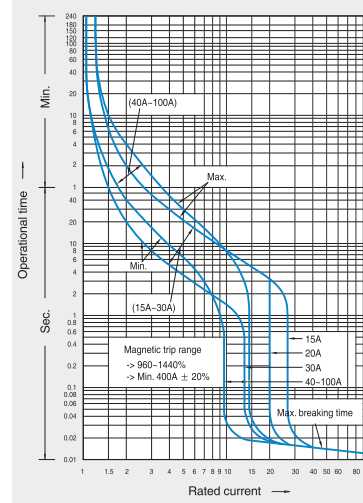

Rated current: 125A

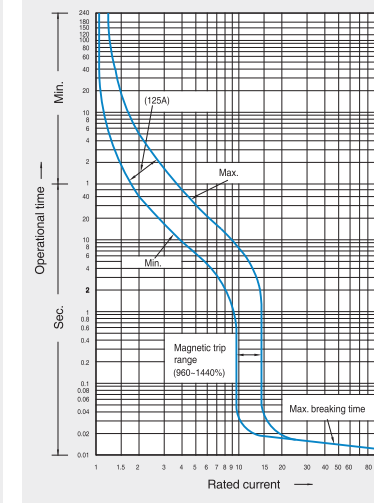

Compensation Curves

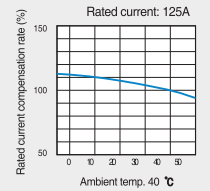
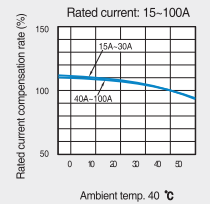

CSC1N, CSC1S & CSC2N

Rated current: 15-30A

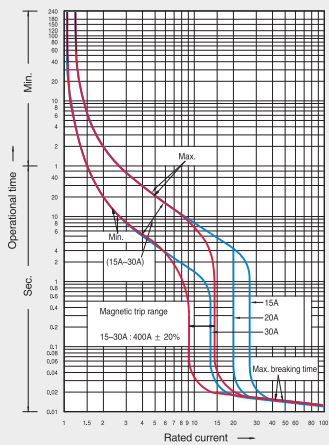

Rated current: 40-100A

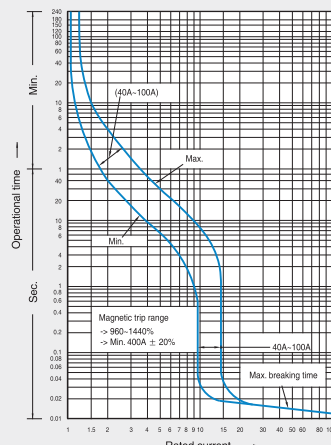

Compensation Curves

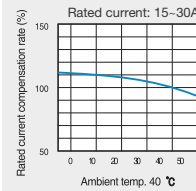

CSC4N, CSC4S & CSC4H

Rated current: 100-225A

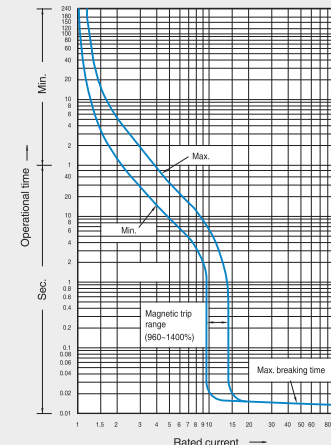

Rated current: 125A

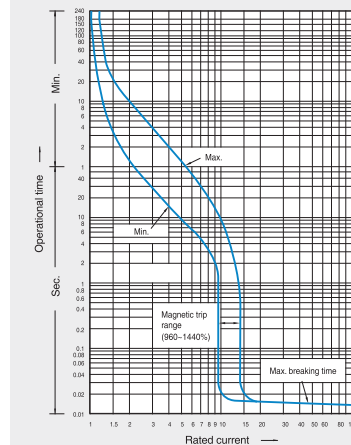

Compensation Curves

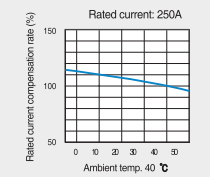
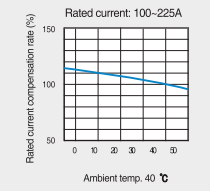

Operating Curve

Overall Dimensions

CSC5N, CSC5S, CSC5H, CSC5L, CSC6N, CSC6S & CSC6L

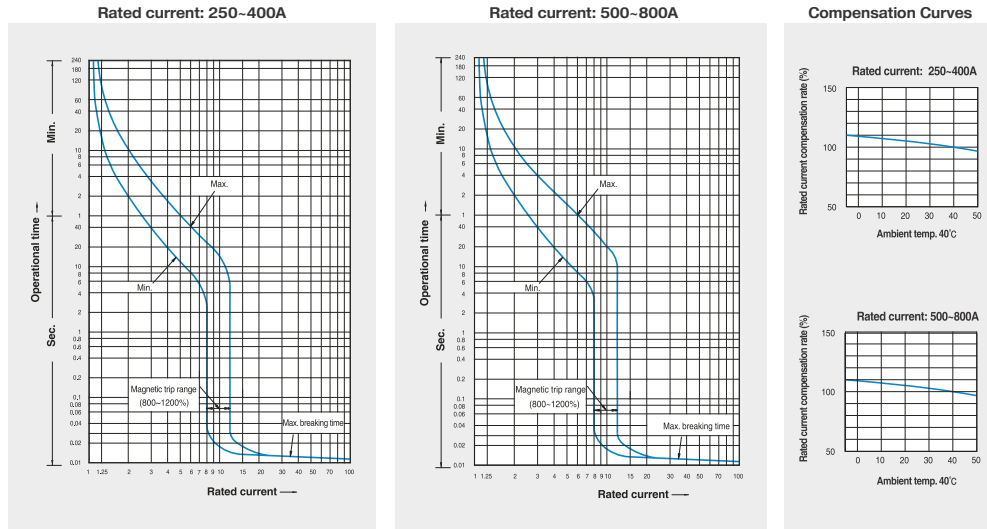

CSC1N, CSC1S & CSC2N

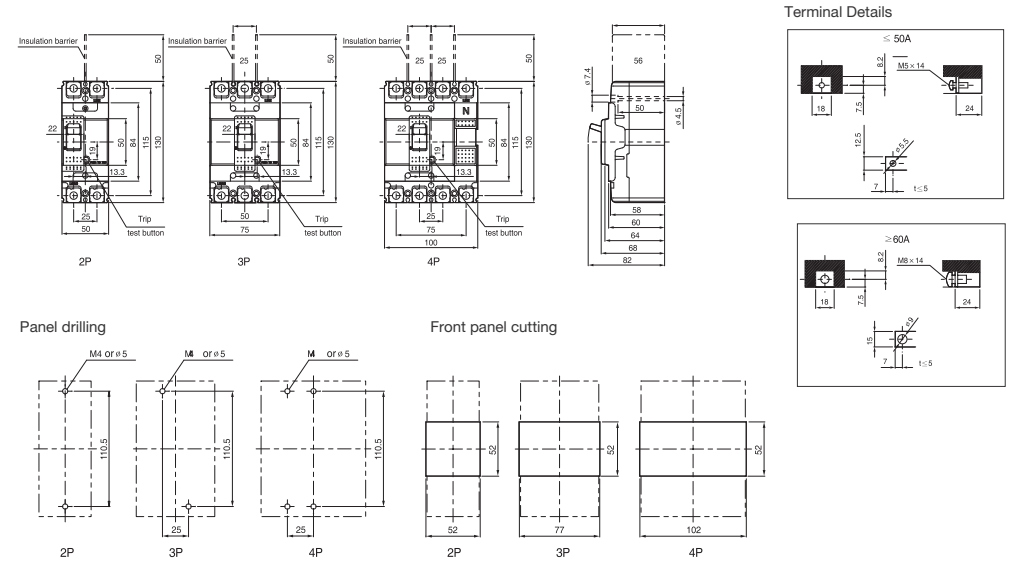

CSC7S, CSC7L & CSC8S

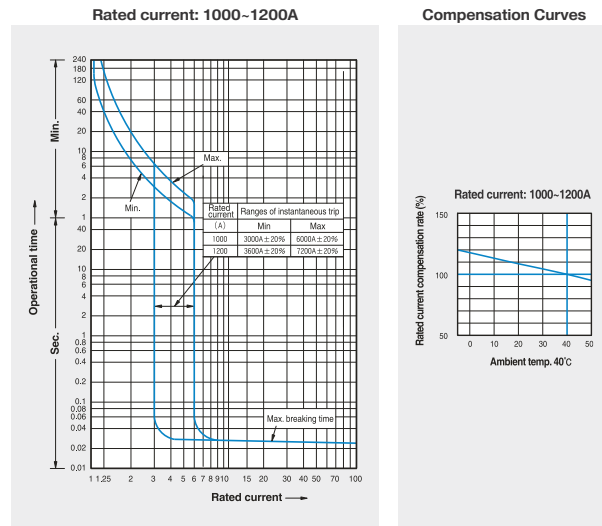

CSC3S & CSC3H

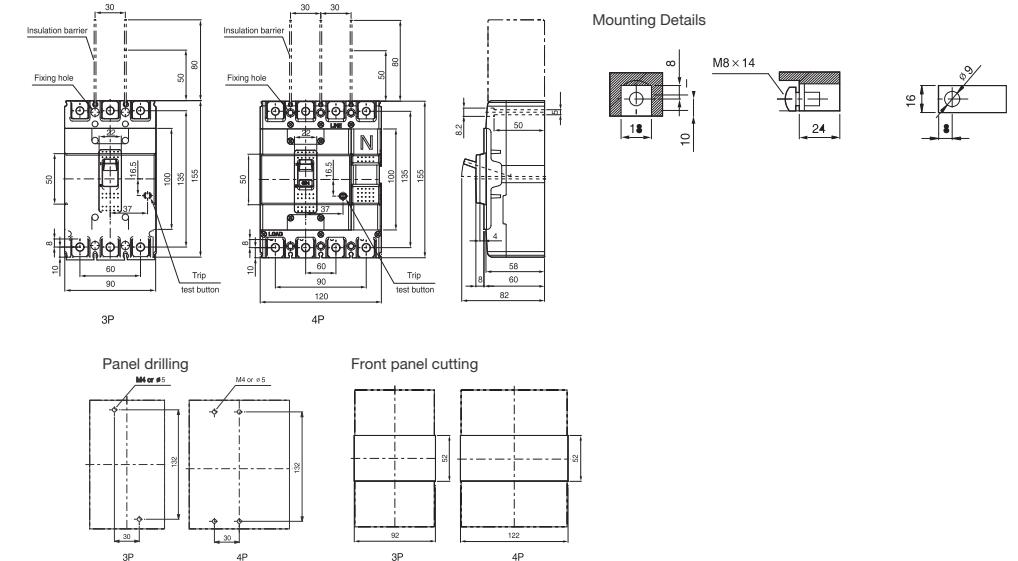

Overall Dimensions

CSC4N, CSC4S & CSC4H

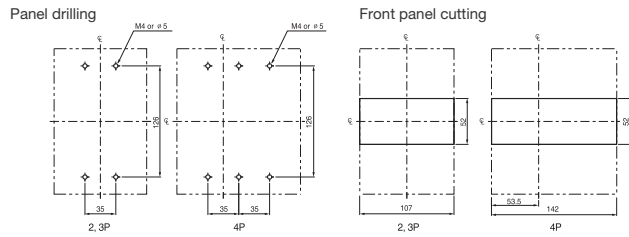
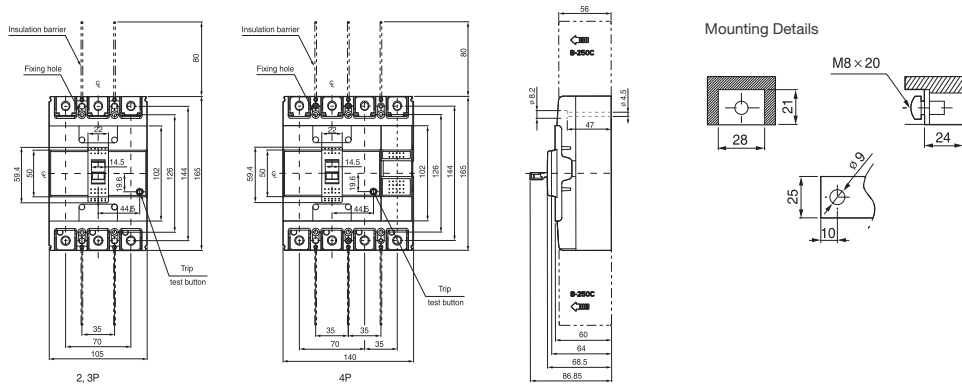

CSC6N, CSC6S & CSC6L

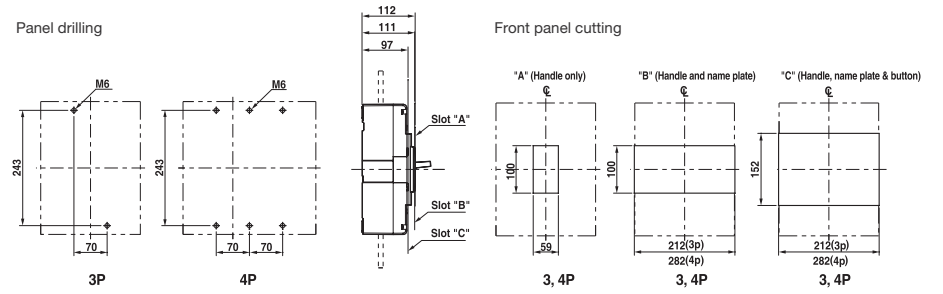
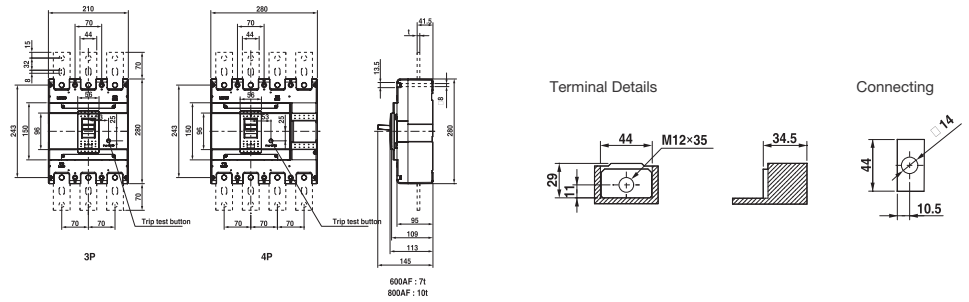

CSC5N, CSC5H, CSC5S & CSC5L

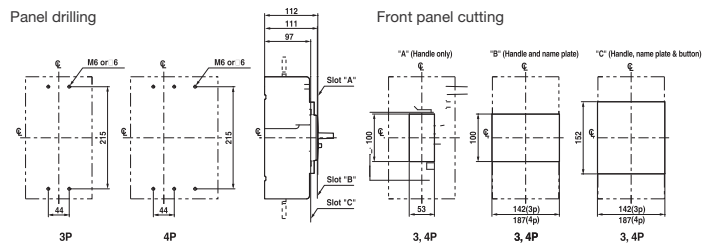
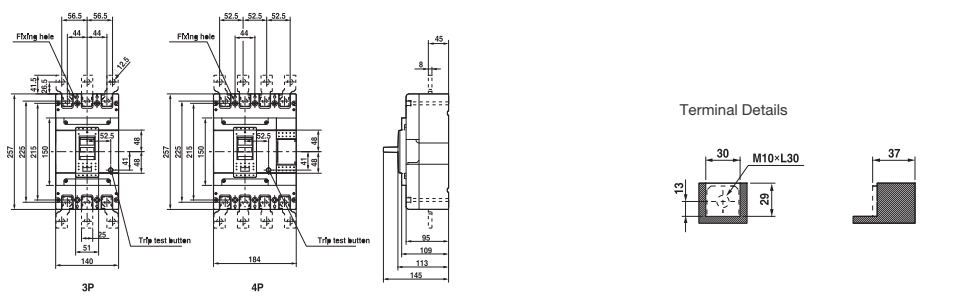

CSC7S, CSC7L, CSC8S & CSC8L

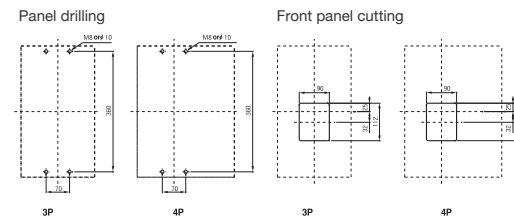
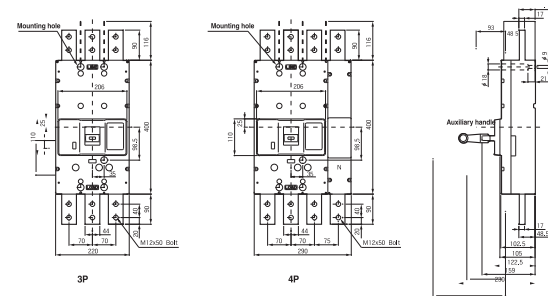

Overall Dimensions

Rotary handle - Direct mounting type (D-handle 50~250AF)

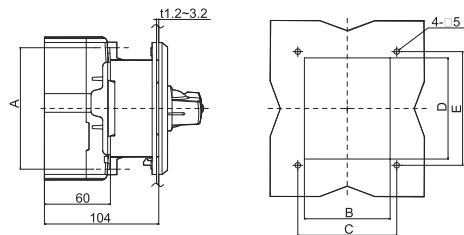

Type	A (mm)	B (mm)	C (mm)	D (mm)	E (mm)	Remarks
DHC100	110.5	78	90	92	103.4	100AF
DHC125	132	94	105	108	120	125AF
DHC250	126	108	121	110	122	250AF

Rotary handle - Direct mounting type (E-handle 50~250AF)

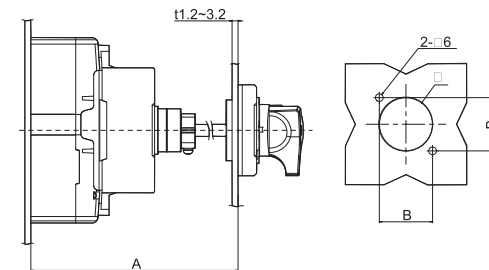

Type	A (mm)	B (mm)	C (mm)	Remarks
EHC100	min 150, max 573.5 (SHAFT469mm)	47	53	100AF
EHC125	min 150, max 573.5 (SHAFT469mm)	47	53	125AF
EHC250	min 150, max 571.5 (SHAFT469mm)	47	53	250AF

Direct mounting type (N-handle 400~800AF)

N-70S, N-70M

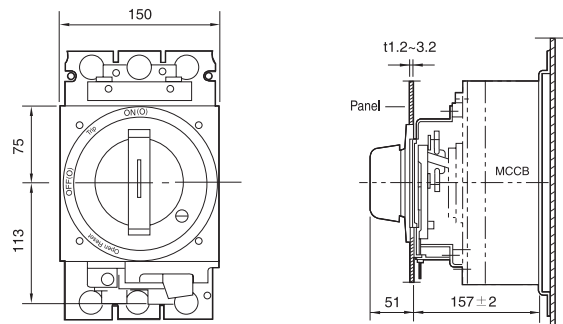

Extended mounting type (N-handle, 400~800AF)

E-70U (400AF)

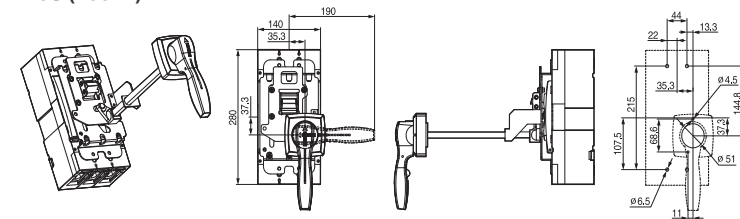

E-80U (800AF)

